

OPERATING INSTRUCTIONS  
for  
**AMPROBE**  
Electrical Test meter

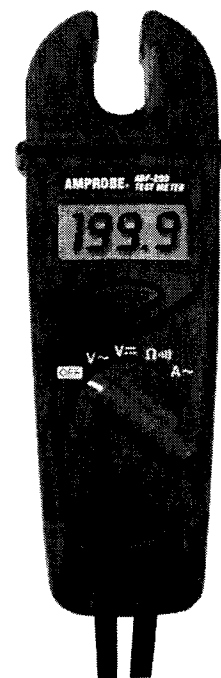

Model ADF-200



**AMPROBE**  
A United Dominion Company

## TABLE OF CONTENTS

WARRANTY .....	3
INTRODUCTION .....	4
Unpacking and Inspection .....	4
SAFETY AND PRECAUTIONS .....	4
Symbols on the product: .....	4
ADF-200 FRONT PANEL OVERVIEW .....	6
OPERATION .....	7
Measuring AC Voltage (V) .....	8
Measuring DC Voltage (V) .....	8
Measuring Continuity and Resistance ( $\Omega$ ) .....	8
Measuring AC Current (A) .....	8
MAINTENANCE .....	10
BATTERY REPLACEMENT .....	11
SPECIFICATIONS .....	12
General specifications .....	12
Environmental conditions .....	12
Voltage .....	13
Resistance & Continuity .....	13
AC Current .....	13
NOTES .....	14

## WARRANTY

Congratulations! You are now the owner of an AMPROBE instrument. It has been crafted according to the highest standards of quality and workmanship. This instrument has been inspected for proper operation of all of its functions and tested by qualified factory technicians according to the long-established standards of AMPROBE INSTRUMENT.

Your AMPROBE instrument has a limited warranty against defective materials and/or workmanship for one year from the date of purchase provided the seal is unbroken or, in the opinion of the factory, the instrument has not been opened, tampered with, or taken apart.

**Should your instrument fail due to defective materials and/or workmanship during the one-year warranty period, return it along with a copy of your dated bill-of-sale which must identify the instrument by model number and manufacturer number.**

**IMPORTANT:** For your protection, please use the instrument as soon as possible. If damaged, or should the need arise to return your instrument, place it in a shipping carton packed with sufficient packing material. It must be securely wrapped. Amprobe is not responsible for damage in transit. Be sure to include a packing slip (indicating model and manufacturer number) along with a brief description of the problem. Make certain your name and address appears on the box as well as packing slip.

Ship prepaid via Air Parcel Post insured or U.P.S. (where available) to:

Service Division  
AMPROBE INSTRUMENT  
630 Merrick Road (use for U.P.S.)  
P.O. BOX 329 (use for Parcel Post)  
Lynbrook, NY 11563-0329

Outside the U.S.A the local Amprobe representative will assist you. Above limited warranty covers repair and replacement only and no other obligation is stated or implied.

## INTRODUCTION

### Unpacking and Inspection

Upon removing The Safest Electrical Tester from its packing, you should have the following items:

1. The Safest Electrical Tester.
2. Instruction manual.

## SAFETY AND PRECAUTIONS

Review the following safety precautions to avoid injury and prevent damage to this product or any products connected to it. To avoid potential hazards, use the product only as specified.

 **CAUTION** - These statements identify conditions or practices that could result in damage to the equipment or other property.

 **WARNING** - These statements identify conditions or practices that could result in personal injury or loss of life.

### Symbols on the product:

 Refer to manual

 Double Insulated

 Battery

## SAFETY AND PRECAUTIONS

1. To avoid personal injury, do not apply any voltage or current to the product without the covers in place.
2. To avoid injury or loss of life, do not touch the metal probe tips while they are connected to a voltage source.
3. To avoid electric shock, do not operate this product in high temperature or high humidity environment.
4. Do not use the tester if it or its test leads appear damaged, or if you suspect that the tester is not operating properly.
5. Never apply more than the rated voltage, as marked on the tester, between a terminal and earth ground.

## ADF-200 FRONT PANEL OVERVIEW

Refer to figure 1 and the following numbered steps to familiarize yourself with the meter's front panel controls and connectors.

- 1. Digital Display** - The liquid crystal display (LCD) is 3 1/2 digit (maximum reading of 1999), with autopolarity and decimal point indicators.
- 2. Measurement Function Dial** - Rotate the function dial to select V~, V<sub>AC</sub>, Ω, and A~ function.
- 3. Display Hold** - To hold the reading on the display, press and release *HOLD*. To exit the display hold mode, press and release *HOLD* again.
- 4. Sensor Zone** - Place conductor anywhere within the sensor zone (shaded area shown as figure 2).

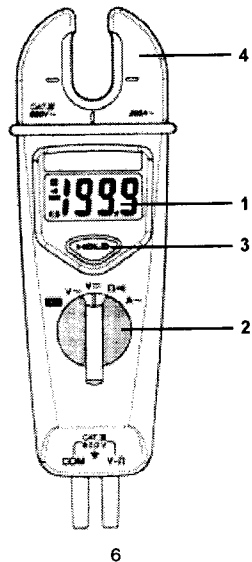

## OPERATION

This instrument has been designed and tested in accordance with IEC Publication 1010, Safety Requirements for Electronic Measuring Apparatus, and has been supplied in a safe condition. This instruction manual contains some information and warnings which have to be followed by the user to ensure safe operation and to retain the instrument in safe condition.

### Precautions and Preparations for measurement

1. If the meter is used near equipment that generates electro-magnetic interference, the display may become unstable and indicate large errors.
2. Make sure that the battery is properly connected.
3. The instrument should only be operated between 32°F - 122°F and at less than 80% R.H.
4. Do not use or store this instrument in a high temperature or high humidity environment and do not store the unit in direct sunlight.
5. Do not replace the battery while the tester is powered on.
6. If the unit is not to be used a long period of time, remove the battery.
7.  Maximum rated voltage to earth for voltage measurement terminals is 1000V CAT II, 600V CAT. III

## OPERATION

### Measuring AC Voltage (V)

1. Rotate the function selector to the V~ position.
2. Connect the probes to the device to be measured.

### Measuring DC Voltage (V)

1. Rotate the function selector to the V  $\equiv$  position.
2. Connect the probes to the device to be measured.

### Measuring Continuity and Resistance ( $\Omega$ )

1. Rotate the function selector to the  $\Omega$   $\rightarrow$  position.
2. Verify that the power to the circuit under test is off. Connect test leads to the circuit to make the measurement.
3. The built in beeper will sound if the resistance of the circuit under test is less than  $25\Omega$ , it will then turn off if the resistance is increased beyond  $400\Omega$ .

### Measuring AC Current (A)

1. Rotate the function selector to the A~ position.
2. Refer to figure 2 and disconnect probes from probe test points.
3. Place the conductor anywhere within the sensor zone as shown in the shaded areas of Fig. 2.

## OPERATION

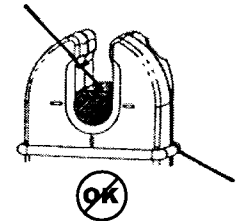
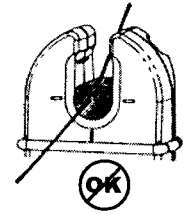
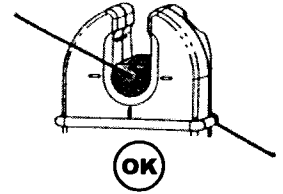
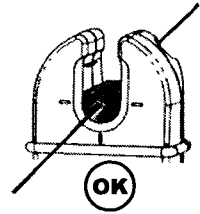

Fig. 2

## MAINTENANCE

Protect the meter from adverse weather conditions. The meter is not waterproof. Do not expose the LCD display to direct sunlight for long periods of time.

**⚠ CAUTION.** To avoid damage to the meter, do not expose it to sprays, liquids, or solvents. Clean the exterior of the meter by removing dust with a lint-free cloth. Use care to avoid scratching the clear plastic display filter. For further cleaning, use a soft cloth or paper towel dampened with water. You can use a 75% isopropyl alcohol solution for more efficient cleaning.

**⚠ CAUTION.** To avoid damage to the surface of the meter, do not use abrasive or chemical cleaning agents.

## BATTERY REPLACEMENT

1. Disconnect the test leads from any circuit under test and turn off meter.
2. Disconnect probes from probe storage on back.
3. Loosen the screw from the battery cover on bottom case.
4. Remove battery cover.
5. Install a new battery after removing the original one.
6. Assemble battery cover onto bottom case with screw driver.

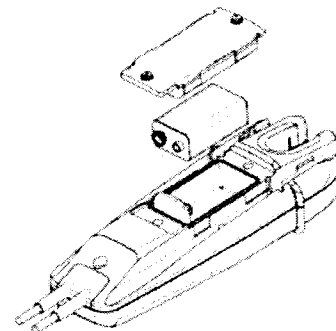

Fig. 3

## SPECIFICATIONS

### General specifications

**LCD display digits:** 3 1/2 digit large scale LCD readout.

**Display count:** 2000 count.

**Measuring Rate:** 2.5 times/sec.

**Overrange display:** "OL" is displayed for "A" and "Ω" functions. Show the real value for "V" function.

**Low voltage indicator:**  is displayed. Replace the batteries when the indicator appears in the display.

**Automatic power off time:** Approximately 13 minutes after power on. To resume operation, turn the tester off, and then on again.

**Power Requirement:** Single 9V battery (NEDA 1604, JIS 006P or IEC6LF22).

### Environmental conditions

**Indoor Use.**

**Calibration:** One-year calibration cycle.

**Operating Temperature:**

32°F to 86°F (0°C - 30°C) ≤ 80% RH

86°F to 104°F (30°C - 40°C) ≤ 75% RH

104°F to 122°F (40°C - 50°C) ≤ 45% RH

**Storage Temperature:**

-4°F to 140°F (-20°C - + 60°C) below 80% RH w/ battery removed.

**Temperature Coefficient:**

0.2 x (spec. accuracy) / °C, <18°C, >28°C.

**Operating Altitude:** 6562 Ft.

**Battery Type and Life:** Alkaline 250 hours (9V or equal).

**Overvoltage Category:** IEC 1010 600V CAT. III, 1000V CAT. II

**Pollution Degree:** 2, Class II

**Shock, Vibration:** Sinusoidal vibration per MIL-T-28800E (5Hz to 55Hz, 3g maximum).

## SPECIFICATIONS

Accuracy is ± (%reading + number of digits) at 73.4°F ± 9°F (23°C ± 5°C), < 80% R.H.

### Voltage

Function	Range	Resolution	Accuracy	Overload Protection
V~	600Vrms	1V	± (1.5%+3d) 40Hz - 500Hz	600Vrms
V---	600VDC	1V	± (1.0%+2d)	600Vrms

**Input Impedance:** 1MΩ // less than 100pF.

### Resistance & Continuity

Function	Range	Resolution	Accuracy	Overload Protection
Ω ◀	2000Ω	1Ω	± (1.0%+2d)	600Vrms

**Max. Open Circuit Voltage:** 3V

**Continuity Check:** Beeper sounds if the resistance of the circuit under test is less than 25Ω. It will then turn off if the resistance is increased beyond 400Ω.

### AC Current

Function	Range	Resolution	Accuracy	Overload Protection
A~	2000A	0.1A	± (3.0%+3d)* 45Hz - 66Hz	200A

**Adjacent Conductor Influence:** <0.05 A / A







**AMPROBE.**  
A United Dominion Company

630 Merrick Road, Lynbrook, NY 11563  
Phone: (516) 593-5600  
Fax: (516) 593-5682  
Tech Support: (800) 477-8658 (VOLT)  
Web: <http://www.amprobe.com>  
Email: [info@amprobe.com](mailto:info@amprobe.com)

Printed in Taiwan